

DIGITAL PANEL METER
N30U



USER'S MANUAL



Contents

| | |
|--|-----------|
| 1. APPLICATION AND METER DESIGN | 5 |
| 2. METER SET..... | 6 |
| 3. BASIC REQUIREMENTS, OPERATIONAL SAFETY | 7 |
| 4. INSTALLATION..... | 8 |
| 5. SERVICE | 11 |
| 6. RS-485 INTERFACE | 29 |
| 7. UPDATING OF SOFTWARE..... | 43 |
| 8. ERROR CODES | 45 |
| 9. TECHNICAL DATA | 46 |
| 10. ORDER CODES | 49 |
| 11. MAINTENANCE AND GUARANTEE..... | 51 |

User's manual for meters with firmware version ≥ 2.00

1. APPLICATION AND METER DESIGN

The N30U meter is a programmable digital panel meter destined for measurements of signals originating from standard sensors destined for temperature measurements and for the measurement of analog standard signals applied in automation. Additionally, the meter enables the indication of the current time. The readout field is a LED display, which allows the exposition of results in colours: red, green and orange. The measured input signal can be arbitrary converted by means of a 21-point individual characteristic.

Features of the N30U meter:

- display colour individually programmed in three intervals,
- programmable thresholds of displayed overflows,
- 2 NOC relay alarms operating in 6 modes,
- 2 switched relay alarms with a switching contact operating in 6 modes (option),
- signaling of measuring range overflow,
- automatic setting of the decimal point,
- programming of alarm and analog outputs with the reaction on the selected input quantity (main or auxiliary input),
- real-time clock with the function of the clock supply support in case of the meter supply decay,
- programmed averaging time – function of walking window with the averaging time up to 1 hour,
- monitoring of set parameter values,
- locking of introduced parameters by means of a password,
- recount of the measured quantity on the base of the 21-point individual characteristic,
- service of the interface with MODBUS protocol in the RTU mode (option),
- conversion of the measured value into a standard – programmable current or voltage signal (option),
- highlight of any measuring unit acc. to the order,

- signaling of alarm operation – switching the alarm on causes the highlight of the output number,
- galvanic separation between connections: alarm, supply, input, analog output, output of the auxiliary supply, RS-485 interface.

Protection grade from frontal side: IP65

Meter overall dimensions: 96 x 48 x 93 mm (with terminals).

The meter casing is made of plastic.



Fig. 1 View of the N30U Digital Meter

2. METER SET

The set is composed of:

- N30U meter 1 pc
- User's manual 1 pc
- Guarantee card 1 pc
- Set of clamps to fix the meter in the panel 4 pcs
- Set of labels with units 2 pcs
- Seal 1 pc

When unpacking the meter, please check whether the type and execution code on the data plate correspond to the order.

3. BASIC REQUIREMENTS, OPTIONAL SAFETY

In the safety service scope, the N30U meter meets the requirements of the EN 61010-1 standard.

Mentioned below applied symbols mean:



- especially important, one must acquaint with this information before connecting the meter. The non-observance of notices marked by this symbol can occasion injuries of the personnel and a damage of the instrument.



- One must take note of this when the instrument is working inconsistently to the expectations. Possible consequences if disregarded.

Observations concerning the operational safety



- All operations concerning transport, installation, and commissioning as well as maintenance, must be carried out by qualified, skilled personnel, and national regulations for the prevention of accidents must be observed.
- Before switching the meter on, one must check the correctness of connections.
- Do not connect the meter to the network through an autotransformer.
- Before removing the meter housing, one must switch the supply off and disconnect measuring circuits.
- The meter is designed to be installed and exploited in electromagnetic industrial environment conditions.
- When connecting the supply, one must remember that a switch or a circuit-breaker should be installed in the building. This switch should be located near the device, easy accessible by the operator, and suitably marked as an element switching the meter off.
- Non-authorized removal of the housing, inappropriate use, incorrect installation or operation, creates the risk of injury to personnel or meter damage. For more detailed information, please study the User's Manual.

4. INSTALLATION

The meter has separable strips with screw terminals, which enable the connection of external wires of 1.5 mm^2 cross-section for input signals and 2.5 mm^2 for other signals.

One must prepare a hole of $92^{+0.6} \times 45^{+0.6} \text{ mm}$ in the panel, which the thickness should not exceed 6 mm.

The meter is adapted to be mounted in a panel. The meter must be introduced from the panel front with disconnected supply voltage. Before the insertion into the panel, one must check the correct placement of the seal. After the insertion into the hole, fix the meter by means of clamps (fig.2).

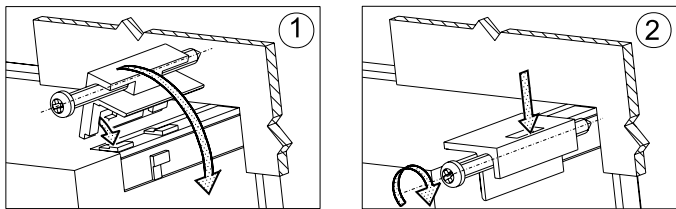

Fig. 2. Meter Fixing

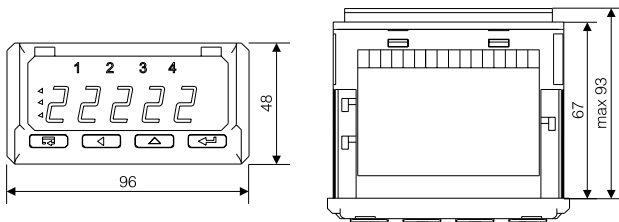

Fig. 3. Overall Dimensions

4.1. Lead-out of Signals

Signals led out on the meter connectors are presented on the fig. 4. Circuits of successive groups of signals are separated between them.

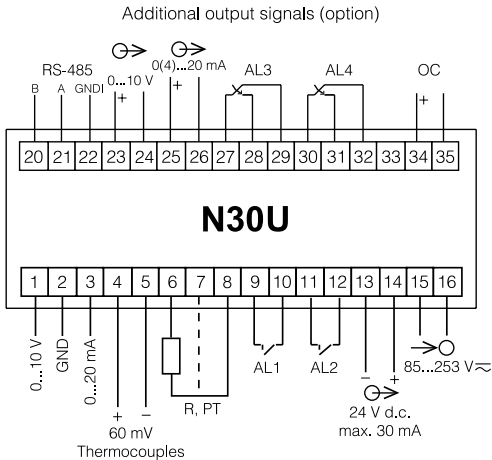

Fig. 4. Description of Signals on Connection Strips

- 0...10 V – input for the measurement ± 10 V voltage,
- GND – mass for the 0...10 V input and 0...20 mA input,
- 0...20 mA – input for the measurement of ± 20 mA current,
- 60 mV TC – input for the measurement of 60 mV voltage, or for the connection of RTD sensors,
- R, PT – input for the resistance measurement or for the connection of RTD sensors. The compensation wire has been marked by a broken line,
- OC – open collector output of npn type– signaling of the measuring range overflow.

4.2. Examples of Connections

An example of the N30U meter connection to different signals is presented on the fig. 5.

Standard signals:

0...10 V and 0...20 mA

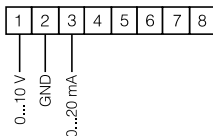

Thermocouple

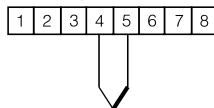

Voltage 0...60 mV

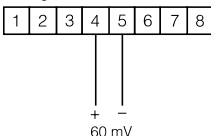

Resistor, RTD sensor
in a two-wire system

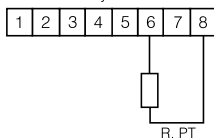

Resistor, RTD sensor
in a three-wire system

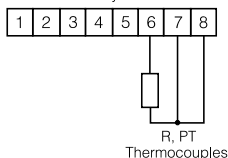

Connection of a two-wire
transducer (4...20 mA)

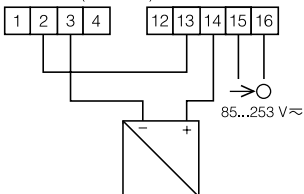

Connection of a three-wire
transducer (0...10 V)

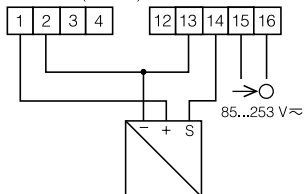

Fig. 5. Ways of the meter Connection

For the connection of input signals in environments with a high noise level, one must apply shielded wires.

5. SERVICE

5.1. Display Description

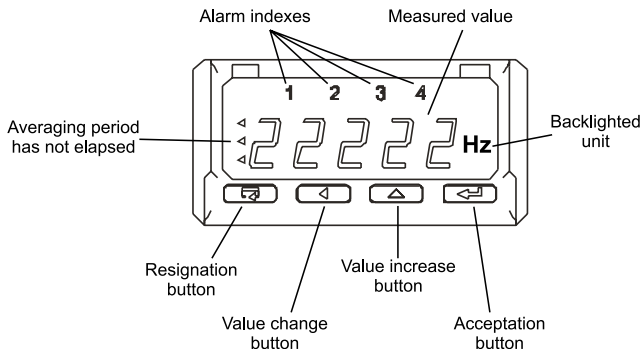

Fig. 6. Description of the Meter Frontal Plate

5.2. Messages after Switching the Supply on

After switching the supply on, the meter displays the meter name N30U and next the program version in the „r x.xx” shape – where x.xx is the number of the current program version or the number of a custom-made execution. Next, the meter carries out measurements and displays the value of the input signal. The meter sets up automatically the decimal point position when displaying the value. The format (number of places after the decimal point) can be limited by the user.

5.3. Functions of Buttons



- **Acceptation button:**

- ⇒ entry in programming mode (hold down ca 3 seconds)
- ⇒ moving through the menu – choice of level,
- ⇒ entry in the mode changing the parameter value,
- ⇒ acceptance of the changed parameter value,
- ⇒ stop the measurement – when holding down the button, the result is not updated. The measurement is still carried out.



- **button increasing the value:**

- ⇒ display of maximal value, The pressure of the button causes the display of the maximal value during ca 3 seconds.
- ⇒ entry in the level of the parameter group,
- ⇒ moving through the chosen level,
- ⇒ change of the chosen parameter value – increasing the value.





- **Button to change the digit:**



- ⇒ display of minimal value, The pressure of the button causes the display of the maximal value during ca 3 seconds.
- ⇒ entry in the level of parameter group,
- ⇒ moving through the chosen level,
- ⇒ change of chosen parameter value – shift on the next digit,



- **resignation button:**





- ⇒ entry in the menu monitoring the meter parameters (by holding down ca 3 seconds),
- ⇒ exit from the menu monitoring meter parameters,
- ⇒ resignation of the parameter change,
- ⇒ absolute exit from the programming mode (by holding down ca 3 seconds).

The pressure of the   button combination and holding them down ca 3 seconds, causes the reset of alarm signaling. This operation acts only when the support function is switched on.

The pressure of the   button combination causes the erasing of the minimal value.

The pressure of the   button combination causes the erasing of the maximal value.

The pressure and holding down the  button ca 3 seconds causes the entry in the programming matrix. The programming matrix can be protected by the safety code.

The pressure and holding down the  button during 3 seconds causes the entry in the menu monitoring meter parameters. One must move through the monitoring menu by means of  and  buttons. In this menu, all programmable meter parameters are only available for readout. In this mode, the menu **Ser** is not available. The exit from the monitoring menu is carried out by means of the  button. In the monitoring menu, parameter symbols are displayed alternately with their values.

The service algorithm of the meter is presented on the fig. 7.

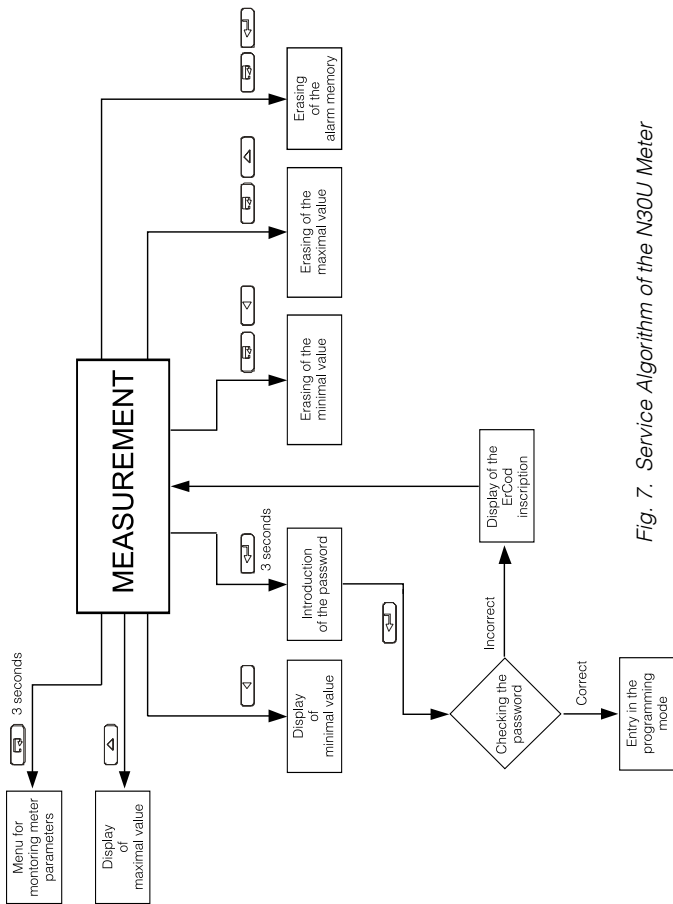













Fig. 7. Service Algorithm of the N30U Meter

5.4. Programming



The pressure of the  button and holding it down through ca 3 seconds causes the entry to the programming matrix. If the entry is protected by a password, then the safety code symbol **SEC** is displayed alternately with the set value **0**. The write of the correct code causes the entry in the matrix, the write of an incorrect code causes the display of the **ErCod** symbol. The matrix of transitions to the programming mode is presented on the fig. 8. The choice of the level is made by means of the  button, however the entry and moving through the parameters of the chosen level is carried out by means of the  and  buttons. Parameter symbols are displayed alternately with their current values. In order to change the value of the chosen parameter, one must use the  button. For resignation from change, one must use the  button. In order to exit from the chosen level, one must chose the ----- symbol and press the  button. To exit from the programming matrix, one must press the  button during ca 1 second. Then, the symbol **End** appears for ca 3 seconds and the meter transits to the display of the measured value. In case of leaving the meter in the parameter programming mode, the automatic abandon of the programming mode follows (parameter, and next the menu) after 30 seconds and the meter transits to display the measured value.

5.4.1. Value Change Way of the Selected Parameter

In order to increase the value of the selected parameter, one must press the  button. A single pressure of the button, causes the increase of the value of 1. The increase of value when displaying the digit 9 causes the set of 0 on this digit. The change of the digit follows after pressing the  button. In order to accept the set parameter, one must hold down the  button. Then, the write of the parameter follows and the display of its symbol, alternately with the new value. The pressure of the  button during the change of the parameter value will cause the resignation of the write.

5.4.2. Changing Floating-Point Values

The change is carried out in two stages (the transition to the next stage follows after pressing the  button):

- 1) setting the value from the range -19999M...99999, similarly as for integral values;
- 2) setting of the decimal point position (00000., 0000.0, 000.00, 00.000, 0.0000); the  button shifts the decimal point to the left, however the  button shifts the decimal point to the right;

The pressure of the  button during the change of the parameter value will cause the resignation of the write.

5.4.3. Characteristic of Programmed Parameters

Programmed parameters and the range of their quantity changes are presented in the table below.

Table 1

| InP 1 | | |
|------------------|------------------------------------|---|
| Parameter symbol | Description | Range of changes |
| tYP1 | Kind of the connected input signal | Pt1 – Pt100 Pt5 – Pt500 Pt10 – Pt1000 rEZL – measurement of resistance up to 400 Ω rEZH – measurement of resistance up to 4000 Ω tE-J – J (Fe-CuNi) tE-h – K (NiCr-NiAl) tE-n – N (NiCrSi-NiSi) tE-E – E (NiCr-CuNi) tE-r – R (PtRh13-Pt) tE-S – S (PtRh10-Pt) O_10U – voltage measurement, range 10 V. O_20A – current measurement, range 20mA O_60n – voltage measurement, range 60mV. HOUr – current time. |

| | | |
|--------------|---|---|
| Con | Choice of the measured value compensation. Concerns only the work in the mode of temperature or resistance measurement. The wire linking the meter with the sensor defines the resistance for RTD sensors, however for thermocouples, the compensation is defined by the cold junction temperature. The choice of a value beyond the range causes the switching of the automatic compensation on. | -19999...99999 Introduction of values: 0..20 Ω - causes the switching of the manual compensation on for the resistance or temperature measurement by means of RTD (resistance thermometers). 0...60°C – causes the switching of the manual compensation on for thermocouples. |
| Cnt1 | The measurement time is expressed in seconds. The result on the display presents the mean value counted in the Cnt1 period. This parameter is not taken into consideration during the measurement in counter modes. | 1...3600 |
| FUnCt | Mathematic functions. Before the individual characteristic the mathematic function is additionally carried out on a measured value. | oFF – no additional mathematic functions sqr – the measured value is squared. sqrt – square root of the measured value Inv –The reciprocal of measured value. InvSq – The reciprocal of the measured value is squared. InvSt – square root of the reciprocal of measured value |

Table 2

| Ind | | |
|-------------------------|--|-------------------------|
| Parameter symbol | Description | Range of changes |
| IndCp | Number of points of the individual characteristic. For a value lower than 2, the individual characteristic is switched off. The number of segments is the number of points decreased of one. The individual characteristic is not taken into consideration in the CountH and HoUr modes. | 1...21 |
| Hn | The point value for which we will expect Yn (n-point number) | -19999...99999 |
| Yn | Expected value for Xn. | -19999...99999 |

Table 3



| dISP | | |
|-------------------------|--|--|
| Parameter symbol | Description | Range of changes |
| d_P | Minimal position of the decimal point When displaying the measured value - display format. This parameter is not taken into consideration during tCountH and HoUr modes. | 0.0000 – 0 00.000 – 1 000.00 – 2 0000.0 – 3 00000 – 4 |
| CoLdo | Display colour, when the displayed value is over than CoLLo | rEd – red grEEen – green orAnG – orange |
| CoLbE | Display colour, when the displayed value is higher than CoLLo and lower than CoLHi | |
| CoLuP | Display colour when the displayed value is higher than CoLHi | |
| CoLLo | Lower threshold of colour change | -19999..99999 |
| CoLHi | Upper threshold of colour change | -19999..99999 |
| ovrLo | Lower threshold of display narrowing Values below the declared threshold are signaled on the display by the  symbol. | -19999..99999 |
| ovrHi | Upper threshold of display narrowing Values above the declared threshold are signaled on the display by the  symbol. | -19999..99999 |

Table 4

| ALr1, ALr2, ALr3, ALr4 | | |
|--|---|---|
| Parameter symbol | Description | Range of changes |
| P_A1 P_A2 P_A3 P_A4 | Input quantity, steering the alarm. | InP1 – Main input (indicated value). HoUr – Real-time clock. |
| tYP1 tYP2 tYP3 tYP4 | Alarm type. Fig. 11 presents the graphical imaging of alarm types | n-on – normal (transition from 0 na 1), n-oFF – normal (transition from 1 na 0), on - switched on, oFF – switched off, H-on – manually switched on; till the change time of the alarm type, the alarm output remains switched on H-oFF – manually switched off; till the change time of the alarm type the output alarm remains switched off for good. |
| PrL1 PrL2 PrL3 PrL4 | Lower alarm threshold. | -19999...99999 |
| PrH1 PrH2 PrH3 PrH4 | Upper alarm threshold. | -19999...99999 |
| dLY1 dLY2 dLY3 dLY4 | Delay of alarm switching. | 0...32400 |



| | | |
|--|---|--|
| <p>LEd1 LEd2 LEd3 LEd4</p> | <p>Support of alarm signaling. In the situation when the support function is switched on, After the alarm state retrea, the signaling diode is not blanked. It signals the alarm state till its blanking moment by means of the   button combination. This function concerns only and exclusively the alarm signaling thus relay contacts will operate without support according to the chosen type of alarm.</p> | <p>off – function switched off on – function switched on</p> |
|--|---|--|

Table 5

| out | | |
|------------------|--|--|
| Parameter symbol | Description | Range of changes |
| P_An | Input quantity, which the analog output has to react on. | <p>InP1 – main input (indicated value). Hour – real-time clock.</p> |
| tyPA | Type of analog output | <p>0_10U – voltage 0...10 V 0_20A – current 0...20 mA 4_20A – current 4...20 mA</p> |
| AnL | Lower threshold of the analog output. give the value, on which we want to obtain the minimal value of signal on the analog output. | -19999...99999 |
| AnH | Upper threshold of the analog output. give the value on which we want to obtain the maximal value of signal on the analog output(10 V or 20 mA). | -19999...99999 |

| | | |
|-------------|---|--|
| bAud | Baud rate of the RS485 interface | 4.8 – 4800 bit/s 9.6 – 9600 bit/s 19.2 – 19200 bit/s 38.4 – 38400 bit/s 57.6 – 57600 bit/s 115.2 – 115200 bit/s |
| prot | Type of transmission frame of the RS-485 interface. | r8n2 r8E1 r8o1 r8n1 |
| Addr | Address in the MODBUS network. The write of the value 0 switches the interface off. | 0...247 |

Table 6

| SEr | | |
|-------------------------|--|--|
| Parameter symbol | Description | Range of changes |
| SEt | Write of manufacturer's settings. The setting of the value YES causes the write of standard parameters into the meter. The value of manufacturer's parameters is presented in the table 7. | no – do nothing. Yes – causes the write of manufacturer's settings. |
| SEC | Introduction of a new password. The introduction of the value 0 switches the password off. | 0...60000 |
| HOUR | Setting of the current time. The introduction of a wrong time cancels the introduction of time. The introduced value is not taken. | 0,00...23,59 |
| unlt | Highlight of the unit. | On – unit highlight switched on. Off – unit highlight switched off. |

| | | |
|-------------|---|--|
| tESt | Display test. The test consists in a successive lighting up of digital display segments. Alarm diodes and unit highlighting diodes should be lighted. | Yes – causes the test start The pressure of the  button ends the test. no – do nothing. |
|-------------|---|--|

5.4.4 Individual Characteristic

N30U meters can recalculated the measured value into any value thanks to the implemented individual characteristic function. The individual characteristic rescales the input signal measured according to the set characteristic. The way of the individual characteristic interaction on the meter operation has been presented on the fig. 9.

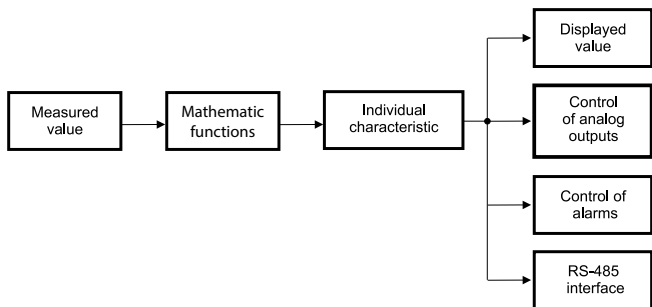
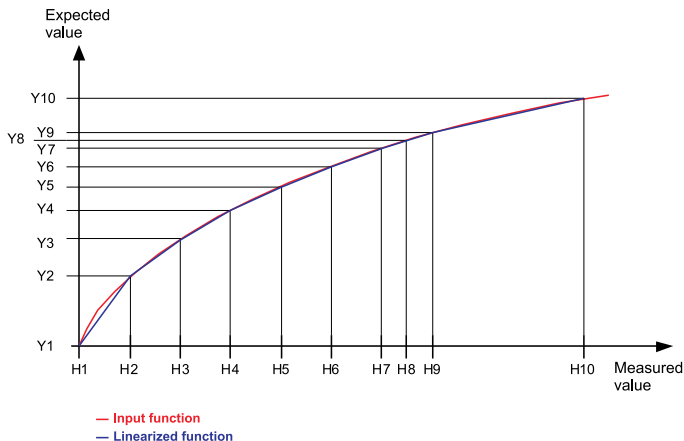

Fig. 9. Action of the Individual Characteristic.

The user can introduce maximally twenty functions through giving intervals and expected values for successive points.

The programming of the individual characteristic consists on the definition of the number of points which the input function will be linearized by. On must remember that the number of linearizing functions is of one

smaller than the number of points. Next, one must program successive points by giving the measured value (H_n) and the expected value corresponding to it, – value which has to be displayed (Y_n). The graphic interpretation of the individual characteristic is presented on the fig. 10.



Rys. 10. Individual Characteristic.

During the function approximation, one must remember that for the approximation of functions strongly differing from the linear characteristic, higher the number of linearizing segments, smaller the error related to the linearization.

If measured values are smaller than H_1 , recalculations will be made on the base of the first straight line calculated on the base of points (H_1, Y_1) and (H_2, Y_2) . However, for values higher than H_n (where n – the last declared measured value) the value to display will be calculated on the base of the last assigned linear function.

Note: All introduced points of the measured value (H_n) must be arran-

ged in the increasing sequence, such to preserve the following dependence:

$$H1 < H2 < H3 \dots < Hn$$

If the above is not fulfilled, the individual characteristic function will be automatically switched off (will not be realized) and a diagnostic flag will be set in the status register.

5.4.5 Alarm types

The N30U meter is equipped with 2 alarm outputs with NOC contact (make contact) and two alarm outputs with NOC/NCC contact (make and break contact) (option). Each of alarms can work in one of the six modes. The work of alarms in modes is presented in the fig. 12: n-on, n-off, on, off. Two remaining modes: h-on and h-off mean suitably, always switched on and always switched off. These modes are destined for the manual simulation of alarm states.

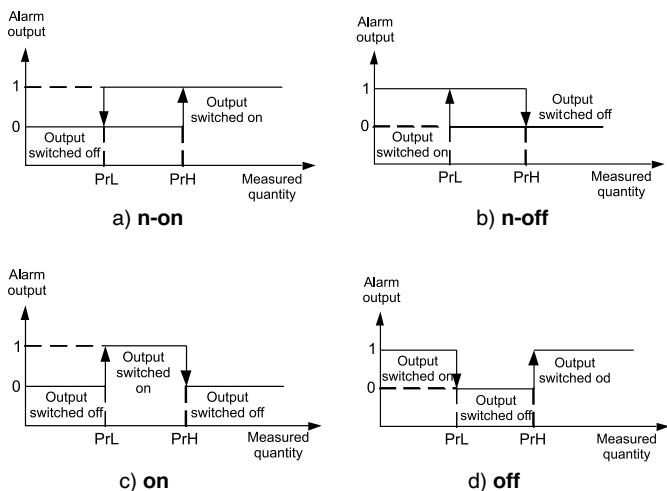

Fig. 11. Alarm Types: a) n-on, b) n-off c) on d) off.



Caution !

- In case of alarms of n-on, n-off, on, off types the write of PrL>PrH will cause the alarm switching off.
- In case of a measuring range overflow, the reaction of the relays is compatible with written PrL, PrH, tYP parameters. In spite of the displayed overflow, the meter still carries out the measurement.
- The meter controls currently the value of the introduced parameter at the moment. In case when the introduced value overflows the upper range given in the table 1, the meter will make automatically the change into the maximal value. Similarly, in case when the introduced value overflows the lower change range given in the table 1, the meter will make automatically the change into the minimal value.

5.4.6 Display Format

The N30U meter adapts automatically the display format (precision) to the value of measured quantity. So that the function could be fully used, one must choose the format **0.0000**, then the meter will display the measured value with the possible highest accuracy. This function does not operate for the time display, where the format is set automatically. The current time (mode HOUr) is displayed in the 24 hours' format, in the shape hh.mm, where hh – current hour, and mm – current minute.

Caution: Remember that the display with a higher resolution is not always desired, it can conduct to a deterioration of the indication stability.

5.5. Manufacturer's Parameters

Standard settings of the N30U meter are presented in the table 7.

These settings can be restored by means of the meter menu through the choice of the option **Set** from the menu **Ser**.

Table 7

| Parametru symbol | Level in the matrix | Standard value |
|---------------------------|---------------------|----------------|
| tYP1 | 1 | Pt1 |
| Con | 1 | 0 |
| Cnt1 | 1 | 1 |
| FUnCt | 1 | off |
| indCP | 2 | no |
| H0 | 2 | 0 |
| Y0 | 2 | 0 |
| H1 | 2 | 100 |
| Y1 | 2 | 100 |
| ... | ... | ... |
| Hn | 2 | $(n-1)*100$ |
| Yn | 2 | $(n-1)*100$ |
| d_P | 3 | 00000 |
| CoLdo | 3 | grEEEn |
| CoLbE | 3 | orAng |
| CoLuP | 3 | rEd |
| CoLLo | 3 | 5000 |
| CoLHi | 3 | 8000 |
| ovrLo | 3 | -19999 |
| ovrHi | 3 | 99999 |
| P_A1, P_A2, P_A3, P_A4 | 4, 5, 6, 7 | lnP1 |
| tYP1, tYP2, tYP3, tYP4 | 4, 5, 6, 7 | h-off |
| PrL1, PrL2, PrL3, PrL4 | 4, 5, 6, 7 | 1000 |

| | | |
|----------------------------|------------|-------------|
| PrH1, PrH2, PrH3, PrH4 | 4, 5, 6, 7 | 2000 |
| dLY1, dLY2, dLY3, dLY4, | 4, 5, 6, 7 | 0 |
| LEd1, LEd2, LEd3, LEd4 | 4, 5, 6, 7 | oFF |
| P_An | 8 | InP1 |
| tYPA | 8 | 0_10U |
| AnL | 8 | 0 |
| AnH | 8 | 99999 |
| bAud | 8 | 9.6 |
| prot | 8 | r8n2 |
| Addr | 8 | 1 |
| SEt | 9 | no |
| SEC | 9 | 0 |
| HOUR | 9 | Not defined |
| unit | 9 | off |
| tESt | 9 | off |

6. INTERFACE RS-485

N30U programmable digital meters have serial links in RS-485 standards for the communication in computer systems and with other devices fulfilling Master function. An asynchronous communication character protocol MODBUS has been implemented on the serial link. The transmission protocol describes ways of information between devices through the serial link.

6.1. Connection Way of the Serial Interface

The RS-485 standard allows to a direct communication of 32 devices on a single serial link of 1200 m long (at baud rate 9600 b/s). For the

connection of a higher quantity of devices, it is necessary to apply additional intermediate-separating systems (e.g. PD51 converter).

The lead out interface line is presented on the fig. 4. To obtain a correct transmission, it is necessary to connect lines A and B in parallel with their equivalents in other devices. The connection must be made through a shielded wire. The wire shield must be connected to the protection terminal in the nearest possible neighbourhood of the meter (connect the shield only in a single point to the protection terminal).

The GND line serves to the additional protection of the interface line at long connections. Then, one must connect GND signals of all devices on the RS-485 bus.

To obtain the connection to the computer, a RS-485 interface card or a suitable converter is indispensable, e.g. PD51 or PD10.

The connection way of devices is shown on the fig. 12

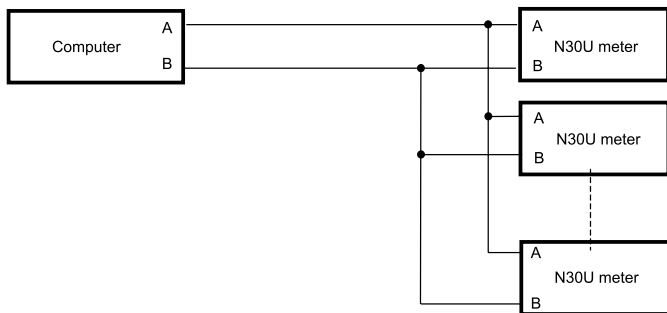

Fig. 12. Connection Way of the RS-485 interface

The designation of transmission lines for the card in the PC computer depends on the card producer.

6.2. Description of the MODBUS Protocol Implementation

The implemented protocol is in accordance with the PI-MBUS-300 Rev G of Modicon Company specification.

Set of the serial link parameters of N30U meters in MODBUS protocol:

- meter address: 1...247,
- baud rate: 4800, 9600, 19200, 38400, 57600, 115200 bit/s,
- work mode: RTU with frame format 8n2, 8e1, 8o1, 8n1,
- maximal response time: 100 ms.

The parameter configuration of the serial link consists in the settlement of the baud rate (**bAUd** parameter), device address (**Addr** parameter), and the format of the information unit (prot parameter)

Notice: Each meter connected to the communication network must have:

- unique address, different from addresses of other devices connected to the network,
- identical baud rate and type of information unit.

6.3 Description of Applied Functions

Following MODBUS functions have been implemented in the N30U meter:

- 03 – readout of the register group
- 04 – readout of input registers
- 06 – write a single register
- 16 – write of the register group
- 17 – identification of the slave device.

6.4 Register map

The register map of the N30U meter is presented below

Notice:

All given addresses are physical addresses. In some computer programs logic addressing is applied, then addresses must be increased of 1.

Table 8

| Range of address | Value type | Description |
|-------------------------|-------------------|--|
| 4000-4049 | integer (16 bits) | Value placed in a 16-bit register. |
| 7000-7039 | float (32 bits) | Value placed in two successive 16-bit registers. Registers include the same data as 32-bit register from the area 7500. Registers are only for readout. |
| 7200-7326 | float (32 bits) | Value placed in two successive 16-bit registers. Registers include the same data as 32-bit register from the area 7600. Registers can be read out and written. |
| 7500-7519 | float (32 bits) | Value placed in a 32-bit register. Registers are only for readout. |
| 7600-7663 | float (32 bits) | Value placed in a 32-bit register. Registers can be read out and written. |

6.5. Registers for Write and Readout

Table 9

| The value is placed in 16-bit registers | Symbol | write (w)/readout (r) | Range | Description |
|---|--------------|-----------------------|----------|---|
| 4000 | tYP1 | w/r | 0...14 | Input type |
| | | | | Value |
| | | | | 0 Pt1 – Pt100 |
| | | | | 1 Pt5 – Pt500 |
| | | | | 2 Pt10 – Pt1000 |
| | | | | 3 rEZL – Resistance, range 400 Ω |
| | | | | 4 rEZL – Resistance, range 4000 Ω |
| | | | | 5 tE-J – J – thermocouple of J type |
| | | | | 6 tE-h – K – thermocouple of K type |
| | | | | 7 tE-n – N – thermocouple of N type |
| | | | | 8 tE-E – E – thermocouple of E type |
| | | | | 9 tE-r – R – thermocouple of R type |
| | | | | 10 tE-S – S – thermocouple of S type |
| | | | | 11 0_10U – voltage measurement, range 10 V |
| | | | | 12 0_20A – current measurement, range 20 mA |
| | | | | 13 0_60n – voltage measurement, range 60 mV |
| | | | | 14 HoUr – current time |
| 4001 | | w/r | | Reserved |
| 4002 | | w/r | | Reserved |
| 4003 | Cnt | w/r | 1...3600 | Measurement time expressed in seconds. This time defines the averaging time of the measured value. The displayed value is the mean value calculated from the Cnt1 period. |
| 4004 | | w/r | | Reserved |
| 4005 | | w/r | | Reserved |
| 4006 | FUnCt | w/r | 0...5 | Mathematic functions carried out on a measured value |
| | | | | Value Description |
| | | | | 0 OFF |
| | | | | 1 Square of measured value |
| | | | | 2 Square root of measured value |

| | | | | | |
|------|--------------|-----|--------|---|---|
| | | | | 3 | The reciprocal of the measured value |
| | | | | 4 | Square of reciprocal of measured value |
| | | | | 5 | Square root of reciprocal of measured value |
| 4007 | | w/r | | Reserved | |
| 4008 | IndCp | w/r | 1...21 | Number of points of the individual characteristic. For the value 1, the individual characteristic is switched off. Segments of the individual characteristic are defined by parameters Xn and Yn, where n – point number. | |
| 4009 | d_P | w/r | 0...4 | Minimal position of the decimal point when displaying the measured value. | |
| | | | | Value | Description |
| | | | | 0 | 0.0000 |
| | | | | 1 | 00.000 |
| | | | | 2 | 000.00 |
| | | | | 4 | 00000 |
| 4010 | CoLdo | w/r | 0...2 | Display colour when the displayed value is smaller than coLLO | |
| | | | | Value | Description |
| | | | | 0 | red |
| | | | | 2 | orange |
| 4011 | CoLbE | w/r | 0...2 | Display colour when the displayed value is higher than coLLO and smaller than coLHI | |
| | | | | Value | Description |
| | | | | 0 | red |
| | | | | 2 | orange |
| 4012 | CoLUp | w/r | 0...2 | Display colour when the displayed value is higher than coLHI | |
| | | | | Value | Description |
| | | | | 0 | red |
| | | | | 2 | orange |
| 4013 | P_a1 | w/r | 0, 1 | Input quantity controlling the alarm | |
| | | | | Value | Description |
| | | | | 0 | Main input |
| | | | | 1 | clock |

| | | | | | |
|------|-------------|-----|-----------|--|----------------------|
| 4014 | tyP1 | w/r | 0...5 | Type of alarm 1 (description – fig. 6) | |
| | | | | Value | Description |
| | | | | 0 | n-on |
| | | | | 1 | n-off |
| | | | | 2 | on |
| | | | | 3 | off |
| | | | | 4 | h-on |
| 5 | h-off | | | | |
| 4015 | dLY1 | w/r | 0...32400 | Delay of alarm 1 (in seconds) | |
| 4016 | LEd1 | w/r | 0...1 | Support of alarm 1 signaling | |
| | | | | Value | Description |
| | | | | 0 | Support switched off |
| | | | | 1 | Support switched on |
| 4017 | P_a2 | w/r | 0, 1 | Input quantity controlling the alarm | |
| | | | | Value | Description |
| | | | | 0 | Main input |
| | | | | 1 | clock |
| 4018 | tyP2 | w/r | 0...5 | Type of alarm 2 (description – fig. 6) | |
| | | | | Value | Description |
| | | | | 0 | n-on |
| | | | | 1 | n-off |
| | | | | 2 | on |
| | | | | 3 | off |
| | | | | 4 | h-on |
| 5 | h-off | | | | |
| 4019 | dLY2 | w/r | 0...32400 | Delay of alarm 2 (in seconds) | |
| 4020 | LEd2 | w/r | 0...1 | Support of alarm 2 signaling | |
| | | | | Value | Description |
| | | | | 0 | Support switched off |
| | | | | 1 | Support switched on |
| 4021 | P_a3 | w/r | 0, 1 | Input quantity controlling the alarm | |
| | | | | Value | Description |
| | | | | 0 | Main input |
| | | | | 1 | clock |

| | | | | | |
|------|-------------|-----|-----------|--|----------------------|
| 4022 | tyP3 | w/r | 0...5 | Type of alarm 3 (description – fig. 6) | |
| | | | | Value | Description |
| | | | | 0 | n-on |
| | | | | 1 | n-off |
| | | | | 2 | on |
| | | | | 3 | off |
| | | | | 4 | h-on |
| 5 | h-off | | | | |
| 4023 | dLY3 | w/r | 0...32400 | Delay of alarm 3 (in seconds) | |
| 4024 | LEd3 | w/r | 0...1 | Support of alarm 3 signaling | |
| | | | | Value | Description |
| | | | | 0 | Support switched off |
| | | | | 1 | Support switched on |
| 4025 | P_a4 | w/r | 0, 1 | Input quantity controlling the alarm | |
| | | | | Value | Description |
| | | | | 0 | Main input |
| | | | | 1 | clock |
| 4026 | tyP4 | w/r | 0...5 | Type of alarm 4 (description – fig. 6) | |
| | | | | Value | Description |
| | | | | 0 | n-on |
| | | | | 1 | n-off |
| | | | | 2 | on |
| | | | | 3 | off |
| | | | | 4 | h-on |
| 5 | h-off | | | | |
| 4027 | dLY4 | w/r | 0...32400 | Delay of alarm 4 (in seconds) | |
| 4028 | LEd4 | w/r | 0...1 | Support of alarm 4 signaling | |
| | | | | Value | Description |
| | | | | 0 | Support switched off |
| | | | | 1 | Support switched on |
| 4029 | P_an | w/r | 0, 1 | Input quantity, which the analog output has to react on. | |
| | | | | Value | Description |
| | | | | 0 | Main input |
| | | | | 1 | clock |

| | | | | | |
|------|--------------|-----|----------|--|--|
| 4030 | tYPa | w/r | 0...2 | Type of analog output | |
| | | | | Value | Description |
| | | | | 0 | voltage input 0...10 V |
| | | | | 1 | current input 0...20 mA |
| | | | | 2 | current input 4...20 mA |
| 4031 | bAud | w/r | 0...5 | Baud rate | |
| | | | | Value | Description |
| | | | | 0 | 4800 bit/s |
| | | | | 1 | 9600 bit/s |
| | | | | 2 | 19200 bit/s |
| | | | | 3 | 38400 bit/s |
| | | | | 4 | 57600 bit/s |
| 5 | 115200 bit/s | | | | |
| 4032 | prot | w/r | 0...3 | Transmission mode | |
| | | | | value | Description |
| | | | | 0 | RTU 8N2 |
| | | | | 1 | RTU 8E1 |
| | | | | 2 | RTU 8O1 |
| 3 | RTU 8N1 | | | | |
| 4033 | Addr | w/r | 0...247 | Meter address. The write of the value 0 causes the interface switching off | |
| 4034 | sAvE | w/r | 0...1 | Update transmission parameters. Causes the application of introduced RS-485 interface settings. | |
| 4035 | SEt | w/r | 0...1 | Write of standard parameters | |
| | | | | Value | Description |
| | | | | 0 | without changes |
| | | | | 1 | set standard parameters |
| 4036 | SEc | w/r | 0...6000 | Password for parameters | |
| | | | | Value | Description |
| | | | | 0 | without password |
| | | | | ... | Entry in parameters preceded by a request about the password |
| 4037 | hour | w/r | 0...2359 | Current time | |
| | | | | <p>This parameter occurs in the ggmm format, where: gg - means hours, mm - means minutes. The introduction of a wrong hour will cause the setting of 23, however the introduction of wrong minutes will generate the setting of the value 59.</p> | |

| | | | | | |
|-------|---------------------------------|-----|-----------|---|--|
| 4038 | unit | w/r | 0, 1 | Switch on/off the unit highlight | |
| | | | | Value | Description |
| | | | | 0 | highlight switched off |
| | | | | 1 | highlight switched on |
| 4039 | | w/r | 0, 1 | Reset of extrem values | |
| | | | | Value | Description |
| | | | | 0 | no change |
| | | | | 1 | Reset of min. and max. values |
| ... | ... | ... | ... | Reserved | |
| 4048 | Status1 | w/r | 0...65535 | Meter status. Describes the current state of the meter. Successive bits represent the given event. The bit set on 1 means, that the event took place. Events can be only erased. | |
| | | | | Bit 15 | Break of the supply |
| | | | | Bit 14 | Re-set of the RTC clock |
| | | | | Bit 13 | Not used |
| | | | | Bit 12 | Lack of communication with data memory |
| | | | | Bit 11 | Wrong settings |
| | | | | Bit 10 | Manufacturer' s setting restored |
| | | | | Bit 9 | Lack of measured values in data memory |
| | | | | Bit 8 | Not used |
| | | | | Bit 7 | Output plate is detected |
| | | | | Bit 6 | Output plate – error or lack of calibration |
| | | | | Bit 5 | Not used |
| | | | | Bit 4 | Not used |
| | | | | Bit 3 | Wrong configuration of the individual characteristic |
| | | | | Bit 2 | Not used |
| Bit 1 | Not used | | | | |
| Bit 0 | Averaging period is not elapsed | | | | |
| 4049 | Status2 | w/r | | Meter status. Describes the current state of the meter. Successive bits represent the given event. The bit set on 1 means, that the event took place. Events can be only cancelled. | |
| | | | | Bit 15 | Not used |
| | | | | Bit 14 | Not used |
| | | | | Bit 13 | Not used |
| | | | | Bit 12 | Not used |
| | | | | Bit 11 | Not used |
| | | | | Bit 10 | Not used |
| | | | | Bit 9 | Not used |
| Bit 8 | Not used | | | | |

| | | | | |
|------|---------|-----|-------|---------------------------------|
| 4049 | Status2 | z/o | Bit 7 | LED4 – Signaling of alarm nr 4. |
| | | | Bit 6 | LED3 – Signaling of alarm nr 3. |
| | | | Bit 5 | LED2 – Signaling of alarm nr 2. |
| | | | Bit 4 | LED1 – Signaling of alarm nr 1. |
| | | | Bit 3 | Status of the alarm relay nr 4. |
| | | | Bit 2 | Status of the alarm relay nr 3. |
| | | | Bit 1 | Status of the alarm relay nr 2. |
| | | | Bit 0 | Status of the alarm relay nr 1. |

Table 10

| The value is placed in two successive 16-bit registers. These registers include the same data as 32-bit registers from the area 7600 | The value is placed in 32-bit registers | Symbol | write (w) / read-out (r) | Range | Description |
|--|---|--------------|--------------------------|----------------|--|
| 7200 | 7600 | CoLLo | w/r | -19999...99999 | Lower threshold of the display colour change |
| 7202 | 7601 | CoLHI | w/r | -19999...99999 | Upper threshold of the display colour change |
| 7204 | 7602 | ovrLo | w/r | -19999...99999 | Lower threshold of the display narrowing |
| 7206 | 7603 | ovrHI | w/r | -19999...99999 | Upper threshold of the display narrowing |
| 7208 | 7604 | PRL 1 | w/r | -19999...99999 | Lower threshold of alarm 1 |
| 7210 | 7605 | PrH 1 | w/r | -19999...99999 | Upper threshold of alarm 1 |
| 7212 | 7606 | PRL 2 | w/r | -19999...99999 | Lower threshold of alarm 2 |
| 7214 | 7607 | PrH 2 | w/r | -19999...99999 | Upper threshold of alarm 2 |
| 7216 | 7608 | PRL 3 | w/r | -19999...99999 | Lower threshold of alarm 3 |
| 7218 | 7609 | PrH 3 | w/r | -19999...99999 | Upper threshold of alarm 3 |
| 7220 | 7610 | PRL 4 | w/r | -19999...99999 | Lower threshold of alarm 4 |

| | | | | | |
|------|------|--------------|-----|----------------|---|
| 7222 | 7611 | PrH 4 | w/r | -19999...99999 | Upper threshold of alarm 4 |
| 7224 | 7612 | AnL | w/r | -19999...99999 | Lower threshold of analog output |
| 7226 | 7613 | AnH | w/r | -19999...99999 | Upper threshold of analog output |
| 7228 | 7614 | Con | w/r | -19999...99999 | Reserved |
| 7230 | 7615 | | w/r | 0...60000 | Reserved |
| 7232 | 7616 | | w/r | 0...60000 | Reserved |
| 7234 | 7617 | | w/r | -19999...99999 | Reserved |
| 7236 | 7618 | | w/r | -19999...99999 | Reserved |
| 7238 | 7619 | | w/r | 0...60000 | Reserved |
| 7240 | 7620 | | w/r | 0...60000 | Reserved |
| 7242 | 7621 | | w/r | -19999...99999 | Reserved |
| 7244 | 7622 | H1 | w/r | -19999...99999 | Point of the individual characteristic. Point nr 1 |
| 7246 | 7623 | Y1 | w/r | -19999...99999 | Expected value for the point nr 1 |
| 7248 | 7624 | H2 | w/r | -19999...99999 | Point of the individual characteristic. Point nr 2 |
| 7250 | 7625 | Y2 | w/r | -19999...99999 | Expected value for the point nr 2 |
| 7252 | 7626 | H3 | w/r | -19999...99999 | Point of the individual characteristic. Point nr 3 |
| 7254 | 7627 | Y3 | w/r | -19999...99999 | Expected value for the point nr 3 |
| 7256 | 7628 | H4 | w/r | -19999...99999 | Point of the individual characteristic. Point nr 4 |
| 7258 | 7629 | Y4 | w/r | -19999...99999 | Expected value for the point nr 4 |
| 7260 | 7630 | H5 | w/r | -19999...99999 | Point of the individual characteristic. Point nr 5 |
| 7262 | 7631 | Y5 | w/r | -19999...99999 | Expected value for the point nr 5 |
| 7264 | 7632 | H6 | w/r | -19999...99999 | Point of the individual characteristic. Point nr 6 |
| 7266 | 7633 | Y6 | w/r | -19999...99999 | Expected value for the point nr 6 |
| 7268 | 7634 | H7 | w/r | -19999...99999 | Point of the individual characteristic. Point nr 7 |
| 7270 | 7635 | Y7 | w/r | -19999...99999 | Expected value for the point nr 7 |
| 7272 | 7636 | H8 | w/r | -19999...99999 | Point of the individual characteristic. Point nr 8 |
| 7274 | 7637 | Y8 | w/r | -19999...99999 | Expected value for the point nr 8 |
| 7276 | 7638 | H9 | w/r | -19999...99999 | Point of the individual characteristic. Point nr 9 |

| | | | | | |
|------|------|------------|-----|----------------|--|
| 7278 | 7639 | Y9 | w/r | -19999...99999 | Expected value for the point nr 9 |
| 7280 | 7640 | H10 | w/r | -19999...99999 | Point of the individual characteristic. Point nr 10 |
| 7282 | 7641 | Y10 | w/r | -19999...99999 | Expected value for the point nr 10 |
| 7284 | 7642 | H11 | w/r | -19999...99999 | Point of the individual characteristic. Point nr 11 |
| 7286 | 7643 | Y11 | w/r | -19999...99999 | Expected value for the point nr 11 |
| 7288 | 7644 | H12 | w/r | -19999...99999 | Point of the individual characteristic. Point nr 12 |
| 7290 | 7645 | Y12 | w/r | -19999...99999 | Expected value for the point nr 12 |
| 7292 | 7646 | H13 | w/r | -19999...99999 | Point of the individual characteristic. Point nr 13 |
| 7294 | 7647 | Y13 | w/r | -19999...99999 | Expected value for the point nr 13 |
| 7296 | 7648 | H14 | w/r | -19999...99999 | Point of the individual characteristic. Point nr 14 |
| 7298 | 7649 | Y14 | w/r | -19999...99999 | Expected value for the point nr 14 |
| 7300 | 7650 | H15 | w/r | -19999...99999 | Point of the individual characteristic. Point nr 15 |
| 7302 | 7651 | Y15 | w/r | -19999...99999 | Expected value for the point nr 15 |
| 7304 | 7652 | H16 | w/r | -19999...99999 | Point of the individual characteristic. Point nr 16 |
| 7306 | 7653 | Y16 | w/r | -19999...99999 | Expected value for the point nr 16 |
| 7308 | 7654 | H17 | w/r | -19999...99999 | Point of the individual characteristic. Point nr 17 |
| 7310 | 7655 | Y17 | w/r | -19999...99999 | Expected value for the point nr 17 |
| 7312 | 7656 | H18 | w/r | -19999...99999 | Point of the individual characteristic. Point nr 18 |
| 7314 | 7657 | Y18 | w/r | -19999...99999 | Expected value for the point nr 18 |
| 7316 | 7658 | H19 | w/r | -19999...99999 | Point of the individual characteristic. Point nr 19 |
| 7318 | 7659 | Y19 | w/r | -19999...99999 | Expected value for the point nr 19 |
| 7320 | 7660 | H20 | w/r | -19999...99999 | Point of the individual characteristic. Point nr 20 |
| 7322 | 7661 | Y20 | w/r | -19999...99999 | Expected value for the point nr 20 |
| 7324 | 7662 | H21 | w/r | -19999...99999 | Point of the individual characteristic. Point nr 21 |
| 7326 | 7663 | Y21 | w/r | -19999...99999 | Expected value for the point nr 21 |

6.6. Registers Only for Readout

Table 11

| The value placed in two successive 16-bit registers. These registers include the same data as 32-bit registers from the area 7500 | The value is placed in 32-bit registers | Name | Write (w) /readout (r) | Unit | Name of the quantity |
|---|---|----------------------|------------------------|--------------------|--|
| 7000 | 7500 | Identifier | O | — | Constant identifying the device. The value 183 means the N30U meter |
| 7002 | 7501 | Status | O | — | Status is register describing the current state of the meter |
| 7004 | 7502 | Control | O | % | It is a register defining the control of the analog output |
| 7006 | 7503 | Minimum | O | — | Minimal value of the currently displayed value |
| 7008 | 7504 | Maximum | O | — | Maximal value of the currently displayed value |
| 7010 | 7505 | Displayed value | O | — | Currently displayed value |
| 7012 | 7506 | Current time | O | — | Current time |
| 7014 | 7507 | Wire resistance | O | Ω | Wire resistance - for resistance measurement - measured value |
| 7016 | 7508 | ADC | O | — | ADC (analog-to- digital converter) value |
| 7018 | 7509 | Terminal temperature | O | $^{\circ}\text{C}$ | Temperature of terminals – the measurement is only carried out during the temperature measurement by means of thermoelectric sensors or during time measurements |

| | | | | | |
|------|------|----------------|---|---------------|--|
| 7020 | 7510 | Measured value | O | | Measured value - not recalculated in relation to the individual characteristic, a.s.l. |
| 7022 | 7511 | EMF | O | μV | EMF measured on meter terminals, when measuring temperature by means of thermocouples. |
| 7024 | 7512 | Resistance | O | Ohm | Resistance measured on the mean line – only for the resistance measurement or when measuring temperature by means of resistance thermometers (RTD) |

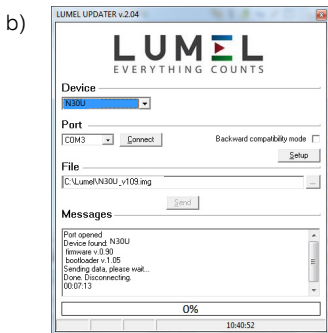
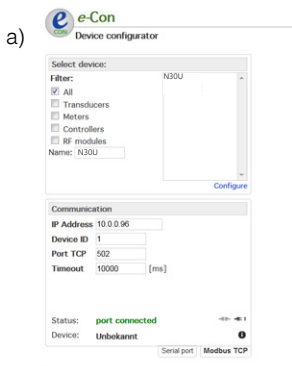

7. UPDATING OF SOFTWARE

Function enabling updating of software from the computer of the PC with software eCon was implementation in meter N30U. Free software eCon and update files are accessible on the site www.lumel.com.pl. The connected to the computer converter RS485 is required on USB to the updating, e.g.: the converter PD10.



Pic. 13. Program view: a) eCon, b) updating of software

Note! After updating the software, the manufacturer's settings of the meter should be set, so it is recommended to save the meter parameters before updating using the software eCon.

After starting eCon's software COM port, baudrate, transmission mode and address should be set. It can be done in *Options*. Then, N30U meter should be selected from *Device*. Push icon *Load* to read and save current settings. Open window *Lumel Updater (LU)* – figure 13b from *Updating->Updating of devices firmware*. Push *Connect*. Update progress is shown in *Messages* section. Text *Port opened* appear after correctly opened port. Putting meter in update's mode can be done in two ways: remote from LU (with settings from eCon – port, baudrate, transmission mode and address) or by turning power on while  button pressed. Meter display shows the „boot“ inscription with bootloader version, LU shows message „*Device found*“ with name and current version of firmware. Using button  browse to the meter upgrade file. If the file is opened correctly, a *File opened* message is displayed. Press the *Send* button. When upgrade is successfully completed, meter reverts to the default settings and begins normal operation while the information window displays *Done* message and upgrade elapsed time. Close LU and go to *Restoration of default parameters*. Select checkbox and press *Apply* button. After the LU window is closed, press the *Save* icon to save all initially read parameters. Current firmware version can be checked when meter is power on.



Warning! Turning the meter off during upgrade process may result in permanent damage!

8. ERROR CODES

After switching the meter to the network or during the work, messages about errors can appear.

Messages about errors and their reasons are presented below.

Table 12

| Error message | Description |
|---|---|
|  | Overflow of upper value of the measuring range value or the programmed indication range. The message can also mean a break in the sensor circuit (thermocouples or resistance thermometers). |
|  | Overflow of lower value of the measuring range value or the programmed indication range. The message can also mean a shorting in the sensor circuit (thermocouples or resistance thermometers). |
| ErFrt | Communication error with the data memory. Contact the service workshop. |
| ErPar | Parameter error. Wrong configuration data. Manufacturer's settings will be restored after pressing any button. |
| ErdEF | Default settings have been restored. Press any button to transit to a normal work. |
| ErFPL | Error of measured values stored by the meter (measured, maximal and minimal values). Press any button to transit to a normal work. After pressing the button during 1 sec, the ErdEF message will be displayed. |
| ErCAo | Lack of calibration of analog outputs. Press any button to transit to the normal work. Analog outputs will not be serviced. Contact the service workshop. |
| ErCAL | Error of calibration. The work is stopped – The meter is not in the state to carry out measurements in a correct way. Incorrect checksum of calibration coefficients or lack of calibration. |

9. TECHNICAL DATA

Measuring ranges

Table 13

| Kind of input | Indication range | Class |
|------------------------|---------------------------------|-------|
| Pt100 | -205...855°C (-200...850°C) | 0.1 |
| Pt500 | | |
| Pt1000 | | |
| 400 Ω | 0...410 Ω (0...400 Ω) | |
| 4000 Ω | 0...4010 Ω (0...4000 Ω) | |
| Thermocouple of J type | -200...1200 °C (-100...1200 °C) | |
| Thermocouple of K type | -200...1370 °C (-100...1370 °C) | |
| Thermocouple of N type | -200...1300 °C (-100...1300 °C) | |
| Thermocouple of E type | -200...1000 °C (-100...1000 °C) | |
| Thermocouple of R type | -50...1768 °C (-50...1760 °C) | |
| Thermocouple of S type | -50...1768 °C (-50...1760 °C) | |
| Voltage input 0...10 V | -13...13 V (-10...10 V) | |
| Current input | -24...24 mA (-20...20 mA) | |
| Voltage input 60 mV | -10...63 mV (0...60 mV) | |
| Current time | 00.00...23.59 | |

Additional error:

- of automatic thermocouple cold junction temperature compensation:
≤ 1 °C
- of automatic wire resistance compensation for thermoresistors:
≤ 0,5 °C
- of automatic wire resistance compensation for resistance measurement:
≤ 0,2 Ω
- of temperature changes: for analog outputs 50 % of the class / 10 K
for analog inputs 100 % of the class / 10 K

Inputs parameters:

- resistance of the supply input [V]: > 1 M Ω
- resistance of the current input [mA]: 12 ± 1 Ω %
- current flowing through the resistance thermometer 270 ± 10 μA
- resistance of wires connecting the resistance thermometer with transmitter: < 10 Ω

| | |
|---|--|
| Relay outputs | - relays, NOC voltageless contacts load capacity 250 V~/0.5A~ - relays, switched voltageless contacts load capacity 250 V~/0.5A~ (option) |
| Analog outputs (option) | - rogrammable, current 0/4..20mA load resistance $\leq 500 \Omega$ - programmable, voltage 0..10V load resistance $\geq 500 \Omega$ |
| Output of auxiliary supply | 24 V d.c./30 mA |
| Alarm output OC (option) | output of OC type, passive npn, 30 V d.c./30 mA. |
| Serial interface | RS-485 (option) |
| Transmission protocol | MODBUS RTU |
| Error of analog output | 0.2% of the set range |
| Protection level ensured by the casing: | |
| - frontal side | IP65 |
| - terminal side | IP10 |
| Weight | < 0.2 kg |
| Overall dimensions | 96 × 48 × 93 mm (with terminals) |
| Reference conditions and rated operating conditions: | |
| - supply voltage | 85...253 V d.c./a.c. 40...400 Hz or 20...40 V a.c. (40...400 Hz), 20...60 V d.c. |
| - ambient temperature | -25... <u>23</u> ...+55°C |
| - storage temperature | -30...+70°C |
| - relative air humidity | 25...95% (inadmissible condensation of water vapour) |
| - work position | any |
| - power consumption | < 6 VA |

Standards fulfilled by the meter:

Electromagnetic compatibility:

- noise immunity acc. to EN 61000-6-2
- noise emissions acc. to EN 61000-6-4

Safety requirements:

acc. to EN61010-1 standard:

- isolation between circuits: basic,
- installation category: III,
- pollution level: 2,
- maximal phase-to-earth work voltage:
 - 300 V for the supply circuit and,
 - 50 V for remaining circuits.
- altitude above sea level: < 2000 m.

10. ORDER CODES

Table 14

| DIGITAL PANEL METER | N30U - | X | X | XX | XX | X | X |
|--|--------|---|---|----|----|----|---|
| Supply: | | | | | | | |
| 85... 253 V a.c. (45...65 Hz) or d.c. | | 1 | | | | | |
| 20...40V a.c. (40...400 Hz) , 20...60 V d.c. | | 2 | | | | | |
| Additional outputs: | | | | | | | |
| lack | | 0 | | | | | |
| OC output, RS485, analog outputs | | 1 | | | | | |
| OCoutput, RS485, analog outputs, switched relay outputs | | 2 | | | | | |
| Unit: | | | | | | | |
| unit code number acc. tab. 15 | | | | | | XX | |
| Version: | | | | | | | |
| standard | | | | | | 00 | |
| custom-made* | | | | | | XX | |
| Language: | | | | | | | |
| Polish | | | | | | | P |
| English | | | | | | | E |
| other* | | | | | | | X |
| Acceptance tests: | | | | | | | |
| without extra quality requirements | | | | | | | 0 |
| with an extra quality inspection certificate | | | | | | | 1 |
| acc. to customer's request* | | | | | | | X |

* - after agreeing with the manufacturer.

ORDER EXAMPLE:

the code: **N30U - 1 0 26 00 E 0** means:

- N30U** – programmable digital meter type,
- 1** – supply: 85...253 V a.c/d.c.(45...65 Hz),
- 0** – lack of additional outputs,
- 26** – unit „°C” acc. to the table 3,
- 00** – standard version,
- E** – English language,
- 0** – without extra quality requirements.

| Code | Unit | Code | Unit |
|------|--------------|------|---------------------|
| 00 | Lack of unit | 29 | % |
| 01 | V | 30 | %RH |
| 02 | A | 31 | pH |
| 03 | mV | 32 | kg |
| 04 | kV | 33 | bar |
| 05 | mA | 34 | m |
| 06 | kA | 35 | l |
| 07 | W | 36 | s |
| 08 | kW | 37 | h |
| 09 | MW | 38 | m ³ |
| 10 | var | 39 | obr |
| 11 | kvar | 40 | szt |
| 12 | Mvar | 41 | imp |
| 13 | VA | 42 | rps |
| 14 | kVA | 43 | m/s |
| 15 | MVA | 44 | l/s |
| 16 | kWh | 45 | rev/min |
| 17 | MWh | 46 | r.p.m. |
| 18 | kvarh | 47 | mm/min |
| 19 | Mvarh | 48 | m/min |
| 20 | kVAh | 49 | l/min |
| 21 | MVAh | 50 | m ³ /min |
| 22 | Hz | 51 | szt/h |
| 23 | kHz | 52 | m/h |
| 24 | Ω | 53 | km/h |
| 25 | k Ω | 54 | m ³ /h |
| 26 | °C | 55 | kg/h |
| 27 | °F | 56 | l/h |
| 28 | K | XX | on order1) |

1) - after agreeing with the manufacturer.

11. MAINTENANCE AND GUARANTEE

The N30U digital panel meter does not require any periodical maintenance.

In case of some incorrect operations:

1. From the Shipping Date, During the Period Given in the Annexed Guarantee Card

One should take the meter down from the installation and return it to the Manufacturer's

Quality Control Dept.

If the meter has been used in compliance with the instructions, the Manufacturer warrants to repair it free of charge.

2. After the Guarantee Period:

One should turn over the meter to repair it in a certified service workshop.

The disassembling of the casing causes the cancellation of the granted guarantee.

Our policy is one of continuous improvement and we reserve the right to make changes in design and specifications of any products as engineering advances or necessity requires and revise the above specifications without notice.



LUMEL S.A.

ul. Sulechowska 1, 65-022 Zielona Góra, POLAND
tel.: +48 68 45 75 100, fax +48 68 45 75 508
www.lumel.com.pl

Export department:

tel.: (+48 68) 45 75 139, 45 75 233, 45 75 321, 45 75 386
fax.: (+48 68) 32 54 091
e-mail: export@lumel.com.pl